

Article number: 3918044035322

Description: Worm gear with st. steel hollow shaft  
VF 44 EP-V-35- 63B5

## Measures

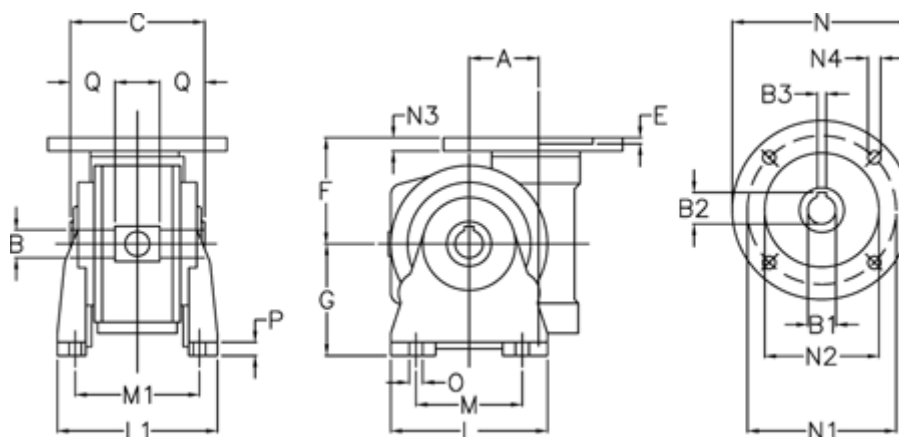

a	= 44.6	g	= 72	N3	= 10.5
B	= 18	L	= 90	N4	= 9.5
B1 E7	= 11	L1	= 98.0	O	= 8.5
B2	= 12.8	m	= 52	P	= 10
B3 H9	= 4	M1	= 81.0	Q	= 24.5
C	= 64	N	= 140		
E	= 2.0	N1	= 115		
F	= 65	N2	= 95		